

INSTATRIKE

BY



Installation Manual Victory Kingpin

Limited Warranty

TOW-PAC, INC. warrants to the first end user purchaser that this product “InstaTrike” when purchased will be free from defective workmanship and materials, and agrees that it will, at its option, either repair the defect or replace the defective Product for the period of one year from date of original purchase.

This warranty does not apply to tires or to the appearance of any item which has been damaged, defaced, been subjected to misuse, or which has been altered or modified in design or construction.

Neither the sales personnel of the seller nor any other person is authorized to make any warranties other than those described above or to extend the duration of any warranties beyond the time period described above on behalf of TOW-PAC, INC.

NOTICE OF LIMITED LIABILITY

Tow-Pac, Inc. warrants *only* components supplied by Tow-Pac, Inc. Tow-Pac, Inc. cannot be responsible for any components on owners motorcycle including frames, hardware, aftermarket accessories, etc. Owner is solely responsible for ensuring motorcycle is in sound mechanical order. Tow-Pac, Inc cannot be responsible for any damage due to improper installation of Tow-Pac components or use of any hardware (bolts, nuts, etc) on Tow-Pac components not supplied directly by Tow-Pac, Inc. Owner is solely responsible for installation of Tow-Pac components. Please refer to limited warranty for warranty details.

Notice

After your InstaTrike is installed, take some time to get used to “Trike” handling characteristics.

- On a Trike you will ***steer*** rather than ***lean*** as you would on a conventional two wheel motorcycle.
- Take corners ***very slowly*** until you get used to the feel of cornering on a Trike.
- Remember to use your front brake in tandem with your rear brake. This will greatly increase your stopping power when in Trike configuration.
- With InstaTrike installed remember the outrigger wheels. Use caution not to run them into objects.
- Keep your feet up at all times.

Important Notices

- InstaTrike is designed for use on paved surfaces *only*. Use of InstaTrike on unpaved terrain may void warranty.
- Installation of InstaTrike requires your motorcycle to be level. Use leveling stands to level motorcycle.
- ***When installing trailer hitch attach all bolts and brackets loosely. After all bolts and brackets are in place tighten all bolts.***

Receiver Hitch Installation

NOTICE: Install all bolts and brackets loosely until all bolts and brackets are in place

NOTICE: Remove any aftermarket accessories (saddle bags, back rests, etc) before hitch installation. After installation remount accessories. NOTE: Some aftermarket accessories may not be compatible with InstaTrike.

- 1) Secure motorcycle in a secure upright position.
- 2) Remove saddle bags and rear rider footboards.
- 3) Attach bracket **A** (left) / **B** (right) to location of rear footboard attachment. Brackets A/B mount between footboard and motorcycle frame.



- 4) Attach bracket **E** (left) / **F** (right) to rear fender sub frame. Mount brackets E/F between rear fender sub frame and saddlebags. Saddle bags mount over brackets E/F. If no saddlebags are present use enclosed 3/8 spacers between

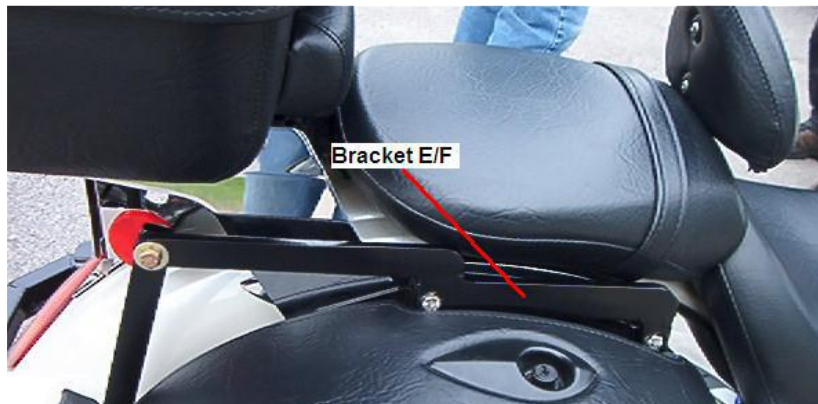

E/F and sub frame.

5) Attach top of brackets **G/H** to rear of brackets E/F. Attach bottom of G/H to rear receiver hitch plate.

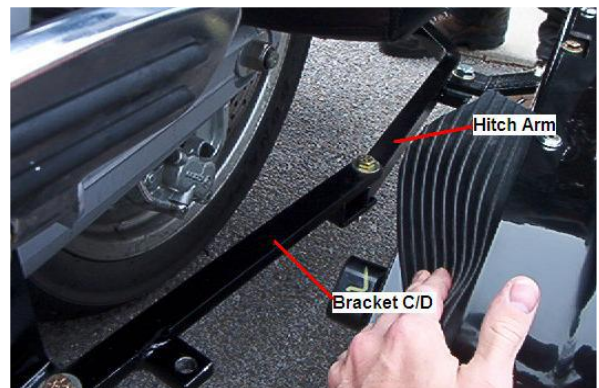
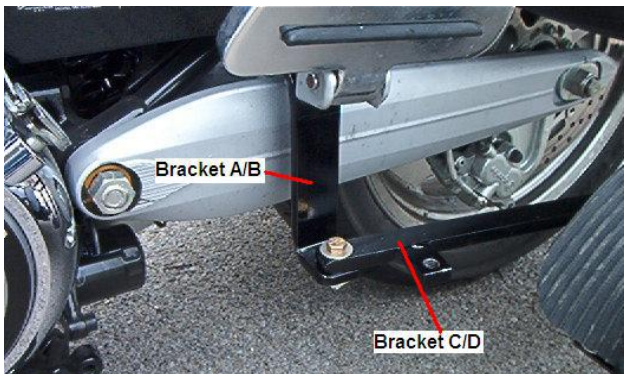



- 6) Attach brackets **C/D** to **TOP** of brackets A/B and **TOP** of forward hitch arms.
- 7) Ensure hitch is square with motorcycle and carefully tighten all bolts.

Periodically recheck bolts for tightness

INSTALLATION OF THE TOW-PAC HITCH CART.

1. Place your motorcycle on a smooth flat surface, like a garage floor, and install leveling stands. *See next page*
2. Assemble the axles, tires and wheels, and fenders onto the tow-pac hitch cart.

3. Carefully align the tow-pac hitch cart's hitch mount with the receiver hitch on the motorcycle. Now push the hitch mount into the receiver hitch. (this might be a little difficult until you get use to doing it. Removing the paint from the hitch mount and applying a little grease will help.) Use enclosed wooden risers under InstaTrike wheels to aid in alignment if necessary.
4. Place the hitch pin through the receiver hitch and hitch mount (*alignment plate*). Install and tighten the tension bolt.
5. Bolt leanstop braces to hitch. (Bolt inserts from the bottom) Be certain to replace washers/spacers in the same configuration as when you removed them. *see diagram next page*
6. Remove leveling stands.
7. Check all bolts for tightness.
8. You are now ready for the test ride.
 - A. Keep your feet up!
 - B. Ride slowly in first gear until you are comfortable with the Tow-Pac system.

Leveling stand screw jack installation

- 1) Thread right side screw jack into threaded leveling stand tab on bracket **B** and adjust leveling jack bolt out.
- 2) Push motorcycle over from left side until right screw jack is touching floor.
- 3) Install left side screw jack on bracket **A** and adjust out until

motorcycle will rest upright on both screw jacks.

4) Adjust screw jacks until motorcycle is level.

CAUTION - Use screw jacks to hold motorcycle upright and level ONLY. Do not lift motorcycle with screw jacks.

CAUTION - Use care when installing screw jacks. Be certain that motorcycle is always in a stable balanced position.

Leanstop Braces

- When installing InstaTrike, bolt leanstop brace to receiver hitch by inserting bolt from *bottom* through the leanstop brace and washers/spacers. Thread bolt into bracket on hitch and tighten.

- When removing InstaTrike reverse the above procedure.
- Adding or removing washers/spacers between receiver hitch and leanstop brace will allow you to level your motorcycle if necessary and adjust traction/handling.

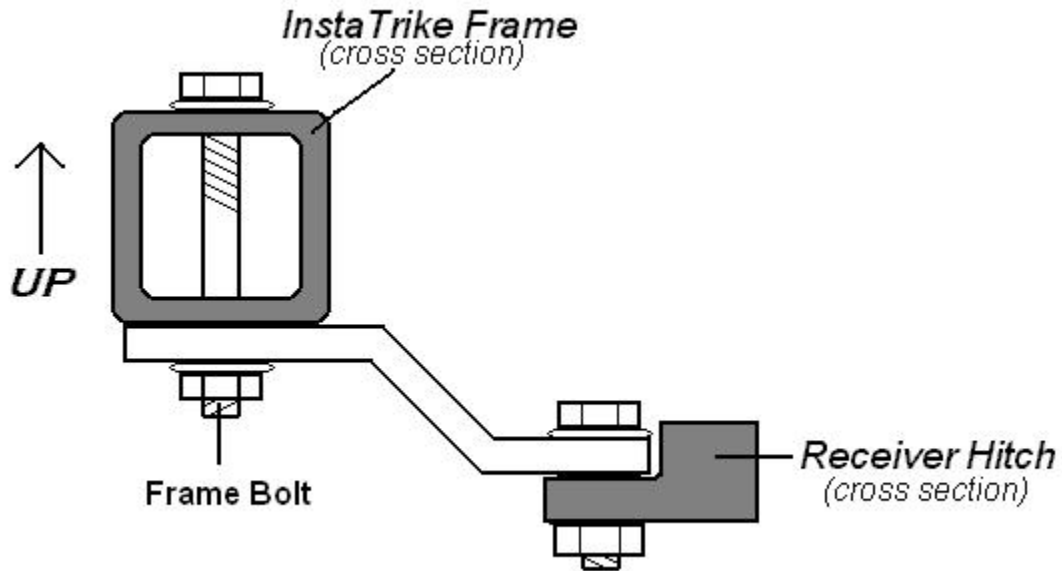

Leanstop brace is slotted to allow for proper alignment with bolt holes

NOTICE:

Be certain that hitch bolts are inserted from the ***TOP***

InstaTrike Assembly Diagram

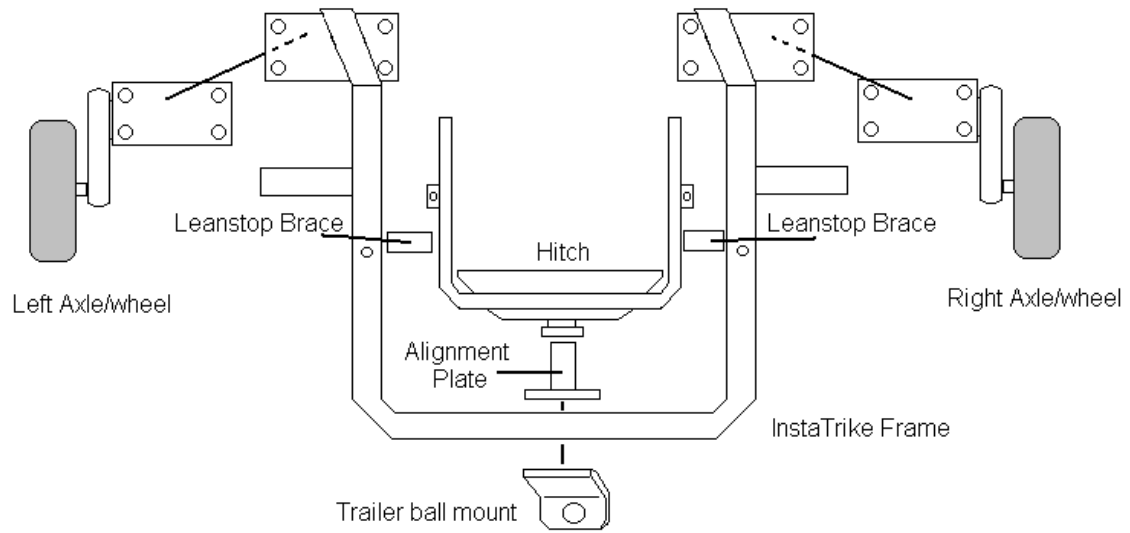

Top View

Wheel Alignment

Wheel alignment is critical for proper tire wear and handling.

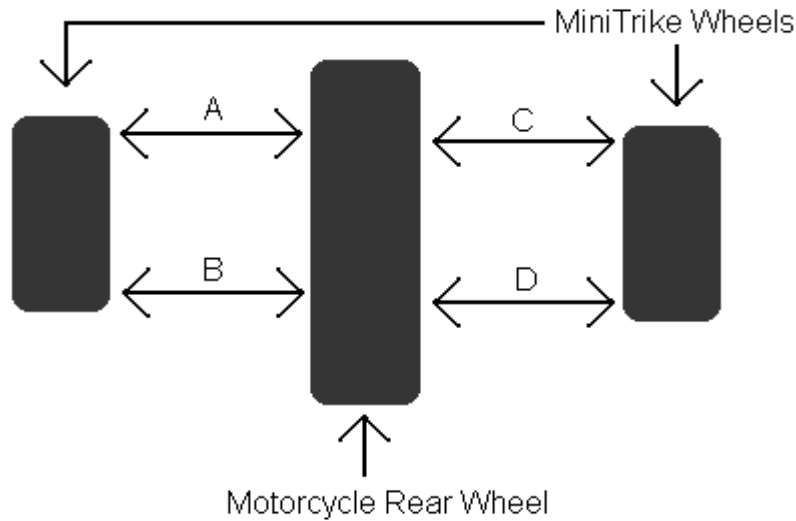

Top View

With InstaTrike installed and motorcycle on center stand, measure **A** and **B**. Loosen axle plates and align wheel so **A** and **B** are equal to within 1/16th of an inch. Tighten axle bolts and torque to 45 pounds. Repeat for **C** and **D**.

NOTE: *The measurement of A and B may not be the same as C and D. This is normal and presents no difficulty.*

Wheel Height / Traction Adjuster

The wheel height/traction adjuster (right and left side) allows you to selectively adjust the position of your trike wheels in order to customize ride, handling, level, and traction characteristics. Your trike is shipped with the adjuster preset to an optimum position for your model of motorcycle however you can make whatever adjustments necessary to customize to your bike and personal

preference.

Shortening the adjuster arm **raises** the trike wheels and places more of the weight of your motorcycle on the motorcycle wheel. This increases motorcycle traction and gives a generally softer ride.

- 1) Loosen jam nuts
- 2) Shorten adjuster arm by turning adjuster nut **A** toward bolt **C** desired amount.
- 3) Turn adjuster nut **B** until it tightens against adjuster bracket and adjuster nut **A**
- 4) Tighten nuts **A** and **B** and jam nuts

Lengthening the adjuster arm **lowers** the trike wheels and places more of the weight of your motorcycle on the trike wheels. This gives a firmer ride and increases handling/cornering.

- 1) Loosen jam nuts
- 2) Lengthen adjuster arm by turning adjuster nut **B** toward bolt **D** desired amount.
- 3) Turn adjuster nut **A** until it tightens against adjuster bracket and adjuster nut **B**
- 4) Tighten nuts **A** and **B** and jam nuts

If necessary the pivot bolt and bolts C and D and be loosened for adjustment
Be certain to retighten all bolts after adjustment.

NOTICE: Check all bolts and nuts periodically for tightness
NOTICE: Be sure motorcycle is level after adjustment.

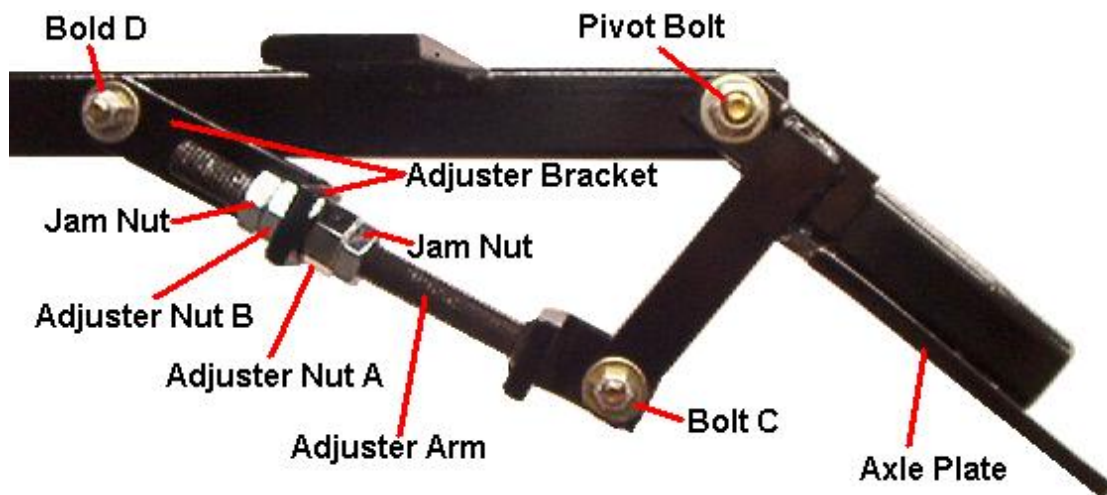

Fender Installation Instructions *(12 Inch wheel only)*

- 1) Attach fender brackets to trike frame with spacers **BETWEEN** fender bracket and frame. Tighten.
NOTE: Leave fender bolts loose until all bolts are inserted.
- 2) Place gray plastic washers between fender and trike frame/fender bracket. (4 washers each side)
- 3) Place fender on frame. Carefully align mounting holes.
- 4) Insert long bolts first. (2 each side)

- 5) Insert short bolts second . (3 each side) **Insert top bolt first.**
- 6) Carefully tighten bolts. Use care not to over tighten.

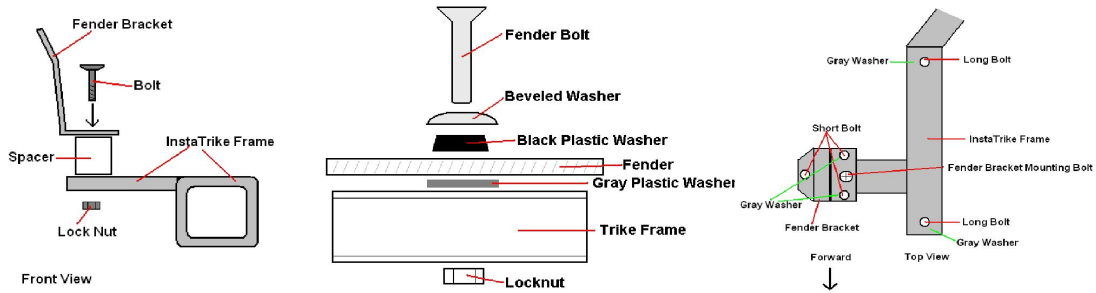

Reflector Mounting Instructions

- 1) Be sure fender is clean and free from dust
Do not apply reflectors in direct sunlight or on a hot surface
- 2) Remove backing from reflector and carefully position on fender.
See Diagram Below

Lightly spraying back of reflectors with a mild solution of water or Windex will allow easier positioning. Allow reflectors at least one hour to dry before riding if using this method.

