

MINITRIKE

BY



Installation Manual

400 Yamaha Majesty

Limited Warranty

TOW-PAC, INC. warrants to the first end user purchaser that this product "MiniTrike" when purchased will be free from defective workmanship and materials, and agrees that it will, at its option, either repair the defect or replace the defective Product for the period of one year from date of original purchase.

This warranty does not apply to tires or to the appearance of any item which has been damaged, defaced, been subjected to misuse, or which has been altered or modified in design or construction.

Neither the sales personnel of the seller nor any other person is authorized to make any warranties other than those described above or to extend the duration of any warranties beyond the time period described above on behalf of TOW-PAC, INC.

NOTICE OF LIMITED LIABILITY

Tow-Pac, Inc. warrants *only* components supplied by Tow-Pac, Inc. Tow-Pac, Inc. cannot be responsible for any components on owners motorcycle including frames, hardware, aftermarket accessories, etc. Owner is solely responsible for ensuring motorcycle is in sound mechanical order. Tow-Pac, Inc cannot be responsible for any damage due to improper installation of Tow-Pac components or use of any hardware (bolts, nuts, etc) on Tow-Pac components not supplied directly by Tow-Pac, Inc. Owner is solely responsible for installation of Tow-Pac components. Please refer to limited warranty for warranty details.

Notice

After your MiniTrike is installed, take some time to get used to “Trike” handling characteristics.

- On a Trike you will ***steer*** rather than ***lean*** as you would on a conventional two wheel motorcycle.
- Take corners ***very slowly*** until you get used to the feel of cornering on a Trike.
- Remember to use your front brake in tandem with your rear break. This will greatly increase your stopping power when in Trike configuration.
- With MiniTrike installed remember the outrigger wheels. Use caution not to run them into objects.
- Keep your feet up at all times.

Important Notices

- ***MiniTrike is designed for use on paved surfaces only. Use of InstaTrike on unpaved terrain may void warranty.***
- ***When installing MiniTrike attach all bolts and brackets loosely. After all bolts and brackets are in place tighten all bolts.***

MiniTrike Installation

NOTE: *Install all bolts loosely until all brackets are in place. Tighten bolts only after all brackets and bolts are in place*

Refer to diagram for bracket identification

1. Secure scooter in an upright stable position
2. Remove center stand.
3. Attach bracket **A** to center stand mounting bracket using new bolts provided. *Longer end to the right*

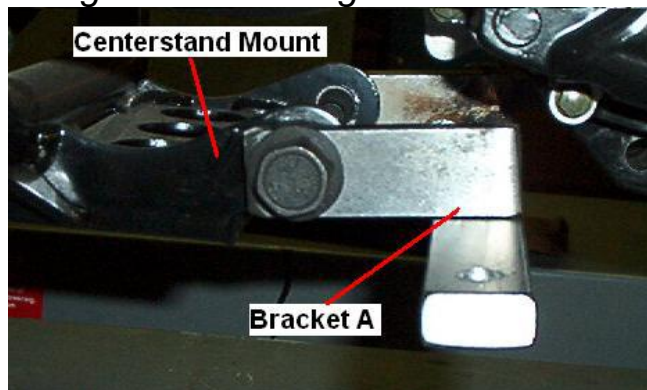

4. Attach axels and wheels to MiniTrike and position in proper relation to scooter.
5. Attach rear of bracket **B** (left) / **C** (right) to **BOTTOM** of forward attaching points on MiniTrike frame.
6. Attach front of bracket **B** (left) / **C** (right) to **TOP** of extending arm on bracket **A**.

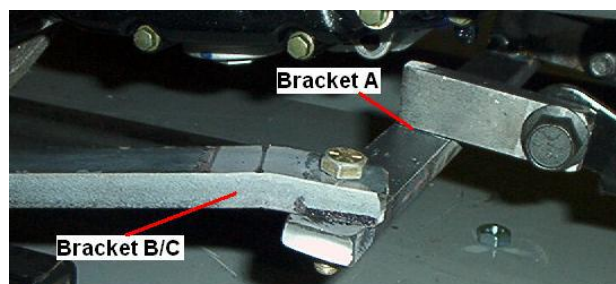

7. Attach top of bracket **F** (left) / **G** (right) to **INSIDE** of top rear shock tower. Replace rear shock bolts with new bolts provided.

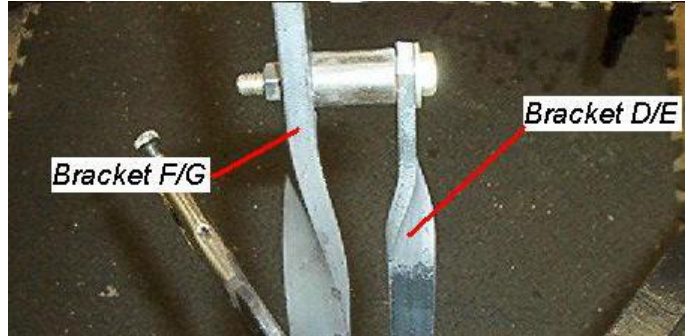
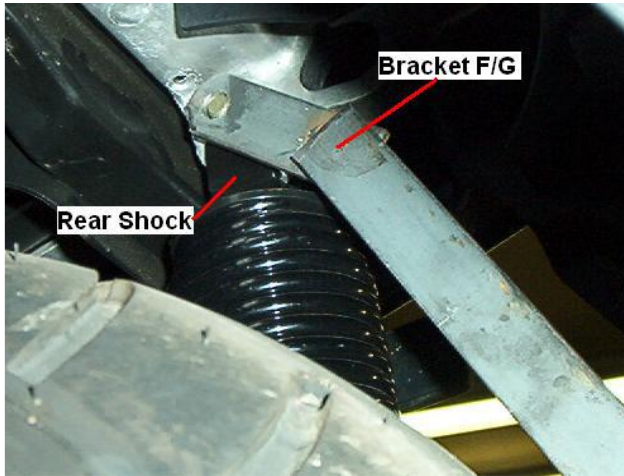

8. Attach bottom of brackets **F/G** to rear frame plate
9. Attach bracket **D**(left) / **E**(right) to brackets **F/G** using spacer in between. Carefully mark hole location on rear hitch plate for bottom of brackets D/E and drill required holes
10. Ensure MiniTrike is square with scooter and tighten all bolts.

After installattaion, MiniTrike will be offset to the right approx 1 inch.

Bracket Identification

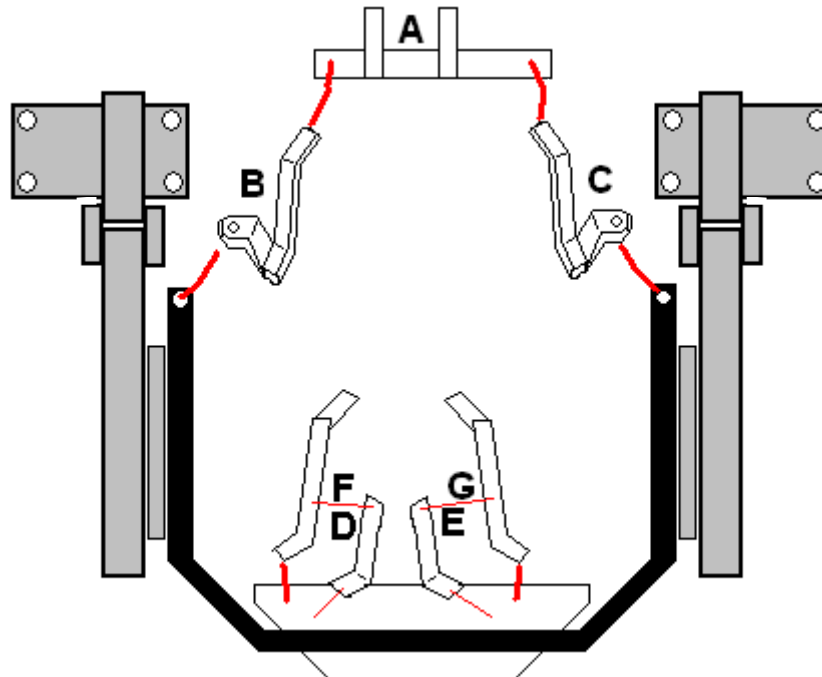

Wheel Alignment

Wheel alignment is critical for proper tire wear and handling.

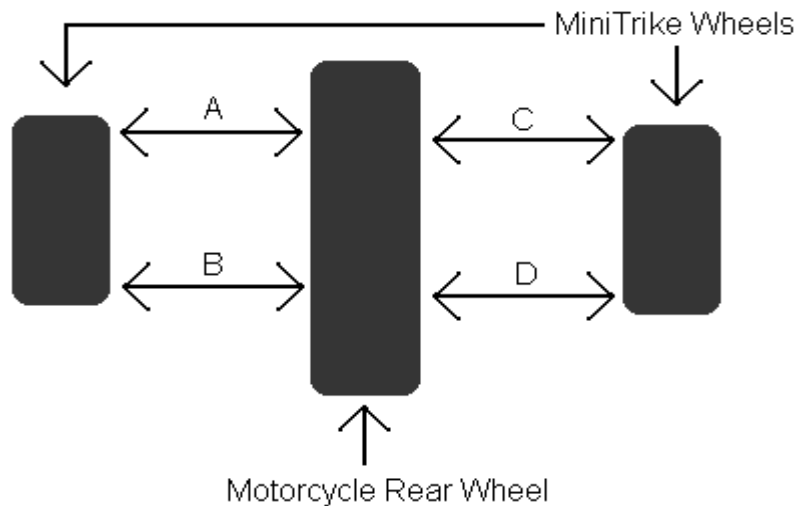

Top View

With MiniTrike installed measure **A** and **B**. Loosen axle plates and align wheel so **A** and **B** are equal to within 1/16th of an inch. Tighten axle bolts and torque to 45 pounds. Repeat for **C** and **D**.

It may be necessary to shim axle plates for proper alignment.

NOTE: *The measurement of A and B may not be the same as C and D. This is normal and presents no difficulty.*

Wheel Height / Traction Adjuster

The wheel height/traction adjuster (right and left side) allows you to selectively adjust the position of your trike wheels in order to customize ride, handling, level, and traction characteristics. Your trike is shipped with the adjuster preset to an optimum position for your model of motorcycle however you can make whatever adjustments necessary to customize to your bike and personal preference.

Shortening the adjuster arm **raises** the trike wheels and places more of the weight of your motorcycle on the motorcycle wheel. This increases motorcycle traction and gives a generally softer ride.

- 1) Loosen jam nuts
- 2) Shorten adjuster arm by turning adjuster nut **A** toward bolt **C** desired amount.
- 3) Turn adjuster nut **B** until it tightens against adjuster bracket and adjuster nut **A**
- 4) Tighten nuts **A** and **B** and jam nuts

Lengthening the adjuster arm **lowers** the trike wheels and places more of the weight of your motorcycle on the trike wheels. This gives a firmer ride and increases handling/cornering.

- 1) Loosen jam nuts
- 2) Lengthen adjuster arm by turning adjuster nut **B** toward bolt **D** desired amount.
- 3) Turn adjuster nut **A** until it tightens against adjuster bracket and adjuster nut **B**
- 4) Tighten nuts **A** and **B** and jam nuts

If necessary the pivot bolt and bolts C and D and be loosened for adjustment

Be certain to retighten all bolts after adjustment.

NOTICE: Check all bolts and nuts periodically for tightness

NOTICE: Be sure motorcycle is level after adjustment.

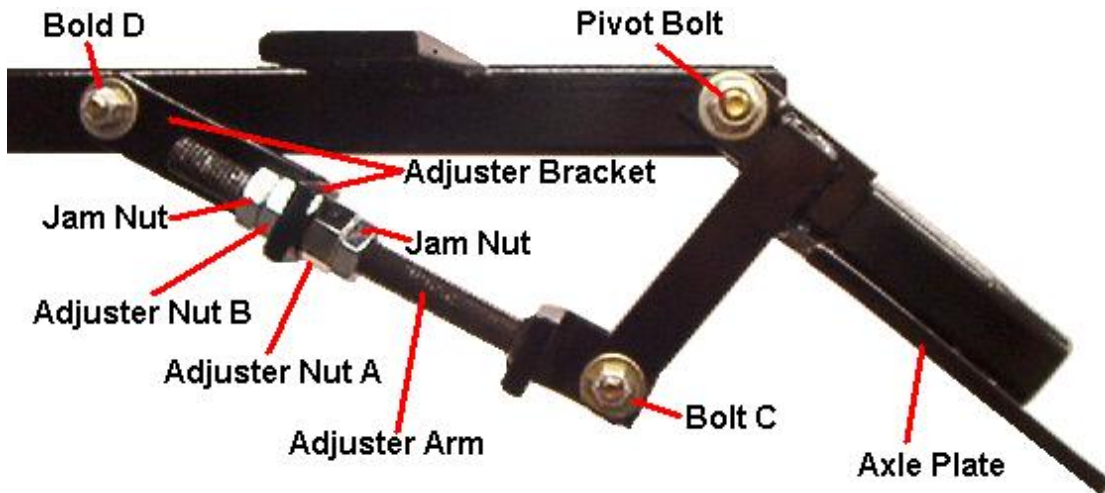

Fender Installation Instructions *(12 Inch wheel only)*

- 1) Attach fender brackets to trike frame with spacers *BETWEEN* fender bracket and frame. Tighten.
NOTE: Leave fender bolts loose until all bolts are inserted.
- 2) Place gray plastic washers between fender and trike frame/fender bracket. (4 washers each side)
- 3) Place fender on frame. Carefully align mounting holes.
- 4) Insert long bolts first. (2 each side)
- 5) Insert short bolts second. (3 each side) *Insert top bolt first.*
- 6) Carefully tighten bolts. Use care not to over tighten.

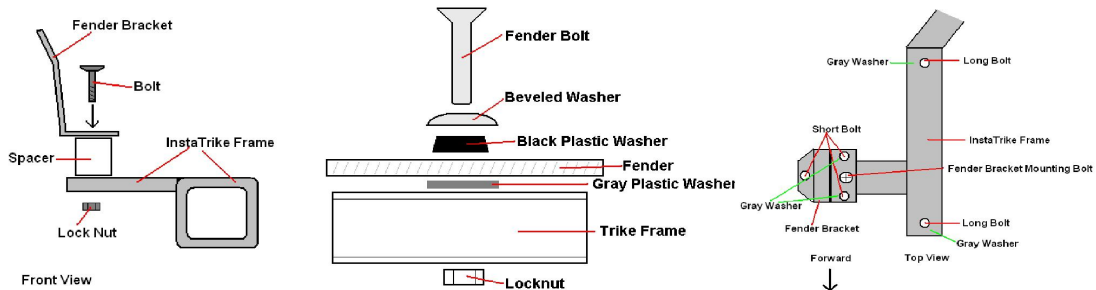

Reflector Mounting Instructions

- 1) Be sure fender is clean and free from dust
Do not apply reflectors in direct sunlight or on a hot surface
- 2) Remove backing from reflector and carefully position on fender.
See Diagram Below

Lightly spraying back of reflectors with a mild solution of water or Windex will allow easier positioning. Allow reflectors at least one hour to dry before riding if using this method.

