

INSTATRIKE

BY



Installation Manual

Kawasaki Concourse

Limited Warranty

TOW-PAC, INC. warrants to the first end user purchaser that this product “InstaTrike” when purchased will be free from defective workmanship and materials, and agrees that it will, at its option, either repair the defect or replace the defective Product for the period of one year from date of original purchase.

This warranty does not apply to tires or to the appearance of any item which has been damaged, defaced, been subjected to misuse, or which has been altered or modified in design or construction.

Neither the sales personnel of the seller nor any other person is authorized to make any warranties other than those described above or to extend the duration of any warranties beyond the time period described above on behalf of TOW-PAC, INC.

NOTICE OF LIMITED LIABILITY

Tow-Pac, Inc. warrants *only* components supplied by Tow-Pac, Inc. Tow-Pac, Inc. cannot be responsible for any components on owners motorcycle including frames, hardware, aftermarket accessories, etc. Owner is solely responsible for ensuring motorcycle is in sound mechanical order. Tow-Pac, Inc cannot be responsible for any damage due to improper installation of Tow-Pac components or use of any hardware (bolts, nuts, etc) on Tow-Pac components not supplied directly by Tow-Pac, Inc. Owner is solely responsible for installation of Tow-Pac components. Please refer to limited warranty for warranty details.

Notice

After your InstaTrike is installed, take some time to get used to “Trike” handling characteristics.

- On a Trike you will ***steer*** rather than ***lean*** as you would on a conventional two wheel motorcycle.
- Take corners ***very slowly*** until you get used to the feel of cornering on a Trike.
- Remember to use your front brake in tandem with your rear brake. This will greatly increase your stopping power when in Trike configuration.
- With InstaTrike installed remember the outrigger wheels. Use caution not to run them into objects.
- Keep your feet up at all times.

Important Notices

- InstaTrike is designed for use on paved surfaces *only*. Use of InstaTrike on unpaved terrain may void warranty.
- Installation of InstaTrike requires your motorcycle to be level. Some motorcycles are not level when on the center stand. Level the motorcycle by placing spacers under the center stand as needed
- ***When installing trailer hitch attach all bolts and brackets loosely. After all bolts and brackets are in place tighten all bolts.***
- Using the enclosed wooden risers under each InstaTrike wheel may make installation and removal easier particularly if traction kit is installed.

Installation Checklist

- Review entire installation manual**
- Remove Saddle Bags and Attaching Hardware**
- Install receiver hitch and double check all bolts**
- Remount saddle bags**
- Assemble InstaTrike hitch cart**
- Attach InstaTrike to motorcycle via receiver hitch**
- Attach leanstop brace bolts to receiver hitch**
- Align InstaTrike wheels**
- Double check all bolts for tightness**
- Test ride InstaTrike slowly in an open area to familiarize yourself with handling characteristics**

Receiver Hitch Installation

NOTICE: *Install all bolts and brackets loosely until all bolts and brackets are in place*

Important Notice - *It may be necessary to remove some aftermarket items (luggage racks, crashbars, etc.) before installation of hitch brackets. After hitch is installed, aftermarket items can be reattached.*

Some aftermarket accessories may not be compatible with InstaTrike.

- 1) Place motorcycle on center stand.
- 2) Remove saddle bags
- 3) Remove saddle bag attaching hardware

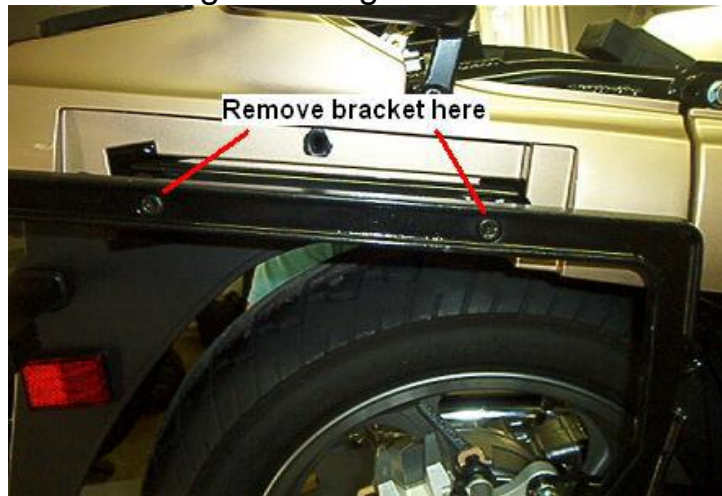

- 4) Remove helmet locks
(Note: *Helmet locks will not be reinstalled*)

- 5) Attach bracket C (left) and bracket D (right) with inner saddle bag bracket to motorcycle using new bolts provided. C and D with inner saddle bag brackets will attach using same bolts.
TIGHTEN THESE BOLTS AT THIS TIME
NOTE: Brackets C and D will be to the inside of the saddle bag mounting brackets.

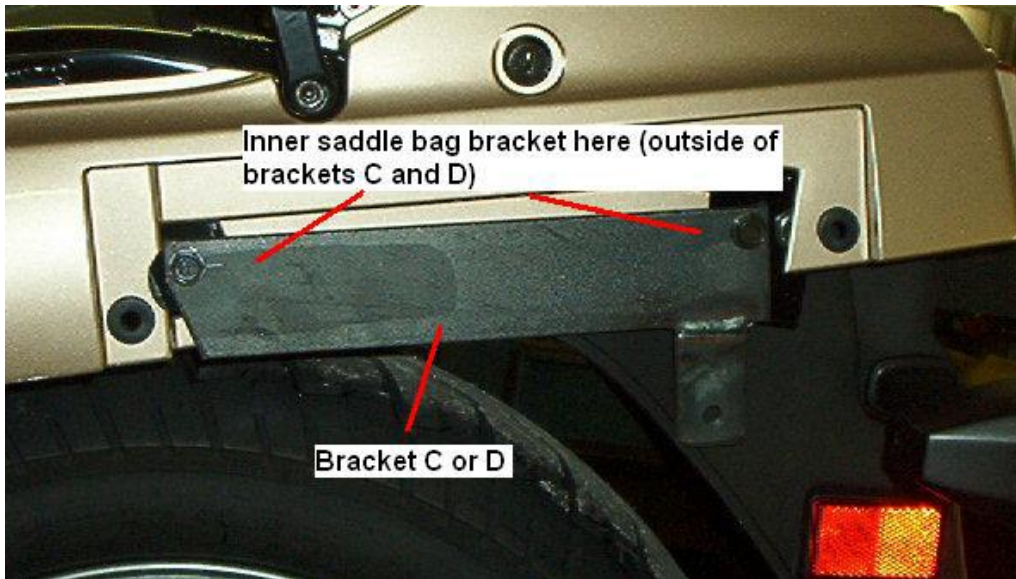

- 6) Reattach outer saddle bag brackets and tighten

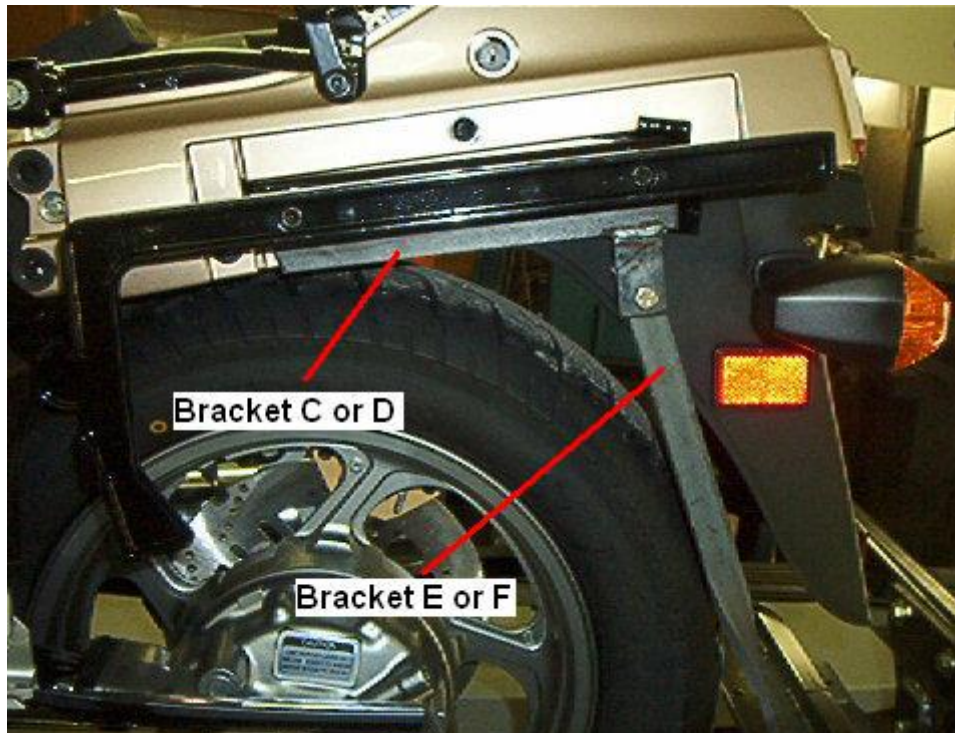

7) Attach brackets E (left) and F (right) to *inside* of tabs on brackets C and D. See *photo on previous page*

8) Attach bracket A (left) and bracket B (right) to muffler mounting point by rear passenger foot pegs. Use *new bolt provided*



9) Attach rear of brackets A and B to *TOP* of forward hitch arms

10) Attach bottom of brackets E and F to rear hitch plate

11) Tighten all bolts

12) Reattach saddle bags

Hitch Diagram

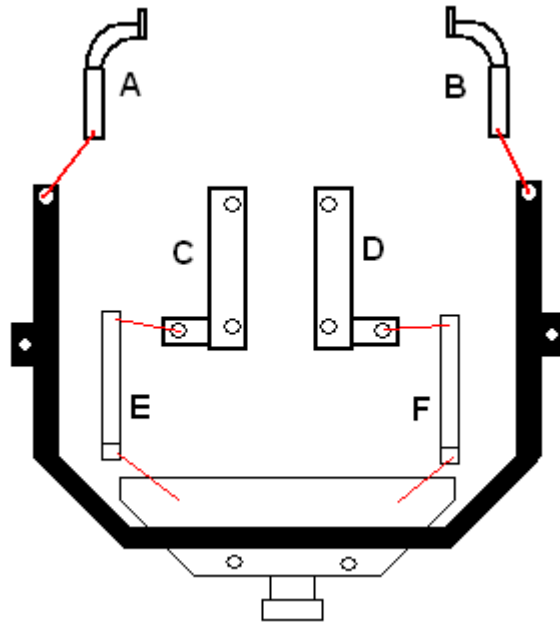

INSTALLATION OF THE TOW-PAC HITCH CART.

1. Place your motorcycle on a smooth flat surface, like a garage floor, and rest it on its center stand.
2. Assemble the axles, tires and wheels, and fenders onto the tow-pac hitch cart.
3. Carefully align the tow-pac hitch cart's hitch mount with the receiver hitch on the motorcycle. Now push the hitch mount into the receiver hitch. (this might be a little difficult until you get use to doing it. Removing the paint from the hitch mount and applying a little grease will help.)
4. Place the hitch pin through the receiver hitch and hitch mount (*alignment plate*). Install and tighten the tension bolt.
5. Bolt leanstop braces to hitch.
6. Push the motorcycle off of the center stand and risers if used.
7. Check all bolts for tightness.
8. You are now ready for the test ride.
 - A. Keep your feet up!
 - B. Ride slowly in first gear until you are comfortable with the Tow-Pac system.

Wheel Alignment

Wheel alignment is critical for proper tire wear and handling.

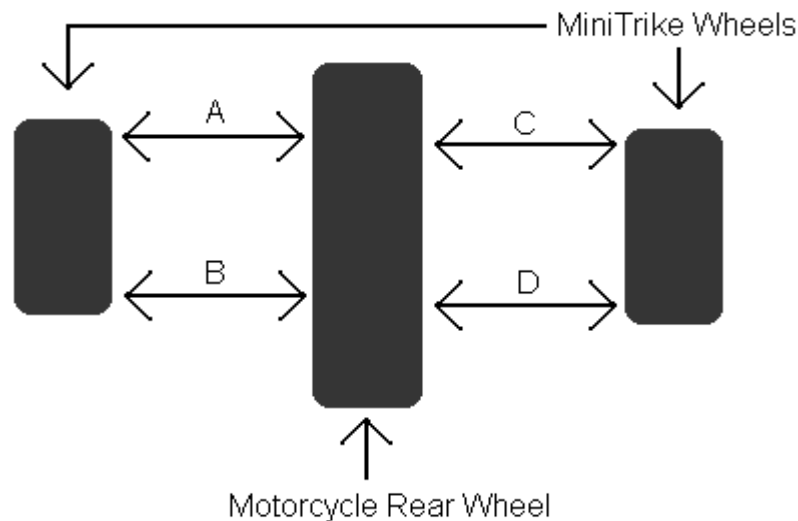

Top View

With InstaTrike installed and motorcycle on center stand, measure **A** and **B**. Loosen axle plates and align wheel so **A** and **B** are equal to within 1/16th of an inch. Tighten axle bolts and torque to 45 pounds. Repeat for **C** and **D**. It may be necessary to shim axle plates for proper alignment.

NOTE: *The measurement of A and B may not be the same as C and D. This is normal and presents no difficulty.*

Wheel Height / Traction Adjuster

The wheel height/traction adjuster (right and left side) allows you to selectively adjust the position of your trike wheels in order to customize ride, handling, level, and traction characteristics. Your trike is shipped with the adjuster preset to an optimum position for your model of motorcycle however you can make whatever adjustments necessary to customize to your bike and personal preference.

Shortening the adjuster arm **raises** the trike wheels and places more of the weight of your motorcycle on the motorcycle wheel. This increases motorcycle traction and gives a generally softer ride.

- 1) Loosen jam nuts
- 2) Shorten adjuster arm by turning adjuster nut **A** toward bolt **C** desired amount.
- 3) Turn adjuster nut **B** until it tightens against adjuster bracket and adjuster nut **A**
- 4) Tighten nuts **A** and **B** and jam nuts

Lengthening the adjuster arm **lowers** the trike wheels and places more of the weight of your motorcycle on the trike wheels. This gives a firmer ride and increases handling/cornering.

- 1) Loosen jam nuts
- 2) Lengthen adjuster arm by turning adjuster nut **B** toward bolt **D** desired amount.
- 3) Turn adjuster nut **A** until it tightens against adjuster bracket and adjuster nut **B**
- 4) Tighten nuts **A** and **B** and jam nuts

If necessary the pivot bolt and bolts C and D and be loosened for adjustment
Be certain to retighten all bolts after adjustment.

NOTICE: Check all bolts and nuts periodically for tightness
NOTICE: Be sure motorcycle is level after adjustment.

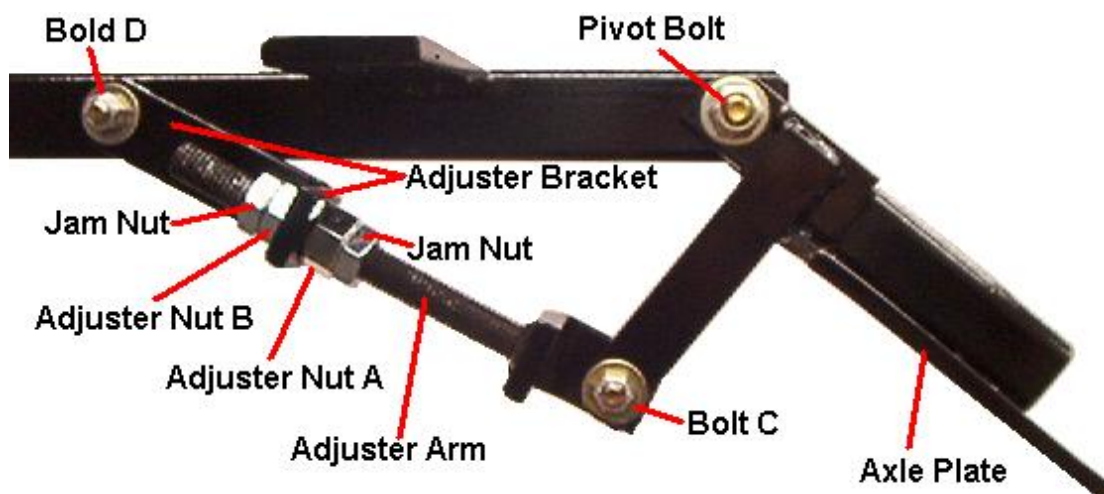

InstaTrike Assembly Diagram

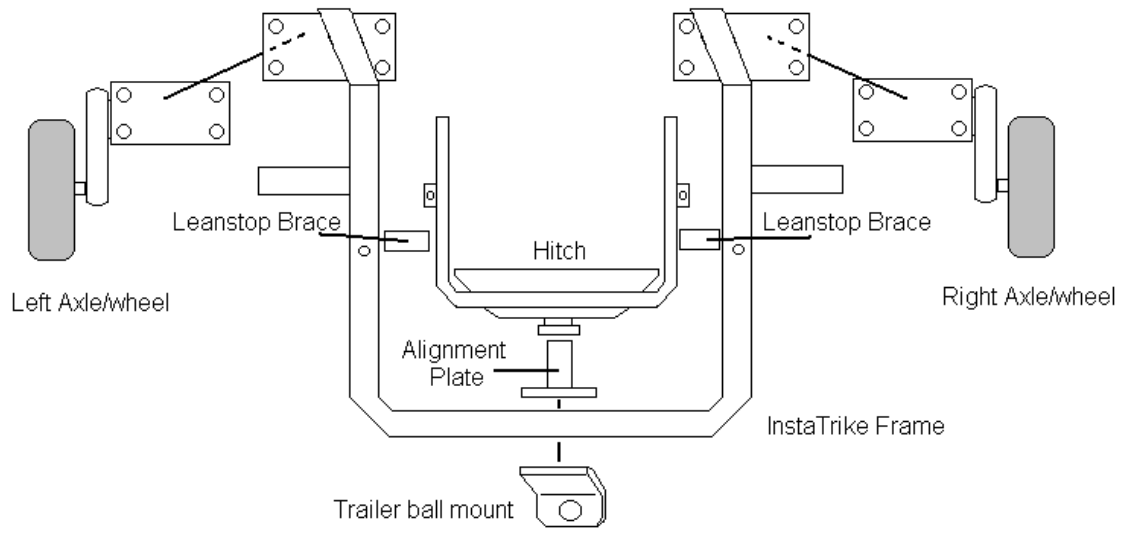

Top View

Fender Installation Instructions *(12 Inch wheel only)*

- 1) Attach fender brackets to trike frame with spacers **BETWEEN** fender bracket and frame. Tighten.
NOTE: Leave fender bolts loose until all bolts are inserted.
- 2) Place gray plastic washers between fender and trike frame/fender bracket. (4 washers each side)
- 3) Place fender on frame. Carefully align mounting holes.
- 4) Insert long bolts first. (2 each side)
- 5) Insert short bolts second. (3 each side) **Insert top bolt first.**
- 6) Carefully tighten bolts. Use care not to over tighten.

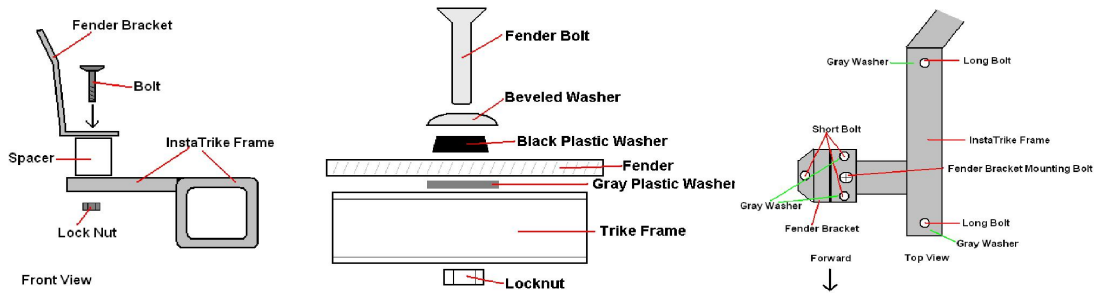

Reflector Mounting Instructions

- 1) Be sure fender is clean and free from dust
Do not apply reflectors in direct sunlight or on a hot surface
- 2) Remove backing from reflector and carefully position on fender.
See Diagram Below

Lightly spraying back of reflectors with a mild solution of water or Windex will allow easier positioning. Allow reflectors at least one hour to dry before riding if using this method.

