

# **INSTATRIKE**

**BY**



**Installation Manual**

**Suzuki Cavalcade**

# Limited Warranty

TOW-PAC, INC. warrants to the first end user purchaser that this product “InstaTrike” when purchased will be free from defective workmanship and materials, and agrees that it will, at its option, either repair the defect or replace the defective Product for the period of one year from date of original purchase.

This warranty does not apply to tires or to the appearance of any item which has been damaged, defaced, been subjected to misuse, or which has been altered or modified in design or construction.

Neither the sales personnel of the seller nor any other person is authorized to make any warranties other than those described above or to extend the duration of any warranties beyond the time period described above on behalf of TOW-PAC, INC.

## **NOTICE OF LIMITED LIABILITY**

Tow-Pac, Inc. warrants *only* components supplied by Tow-Pac, Inc. Tow-Pac, Inc. cannot be responsible for any components on owners motorcycle including frames, hardware, aftermarket accessories, etc. Owner is solely responsible for ensuring motorcycle is in sound mechanical order. Tow-Pac, Inc cannot be responsible for any damage due to improper installation of Tow-Pac components or use of any hardware (bolts, nuts, etc) on Tow-Pac components not supplied directly by Tow-Pac, Inc. Owner is solely responsible for installation of Tow-Pac components. Please refer to limited warranty for warranty details.

# Notice

***After your InstaTrike is installed, take some time to get used to “Trike” handling characteristics.***

- On a Trike you will ***steer*** rather than ***lean*** as you would on a conventional two wheel motorcycle.
- Take corners ***very slowly*** until you get used to the feel of cornering on a Trike.
- Remember to use your front brake in tandem with your rear brake. This will greatly increase your stopping power when in Trike configuration.
- With InstaTrike installed remember the outrigger wheels. Use caution not to run them into objects.
- Keep your feet up at all times.

# **Important Notices**

- ***InstaTrike is designed for use on paved surfaces only. Use of InstaTrike on unpaved terrain may void warranty.***
- ***When installing trailer hitch attach all bolts and brackets loosely. After all bolts and brackets are in place tighten all bolts.***
- ***Periodically (every 1000 miles) check bolts for tightness.***

# Installation Checklist

- Review entire installation manual**
- Remove saddle bags**
- Install receiver hitch and double check all bolts**
- Remount saddle bags**
- Assemble InstaTrike hitch cart**
- Attach InstaTrike to motorcycle via receiver hitch**
- Attach leanstop brace bolts to receiver hitch**
- Align InstaTrike wheels**
- Double check all bolts for tightness**
- Test ride InstaTrike slowly in an open area to familiarize yourself with handling characteristics**

# Receiver Hitch Installation

***Install all bolts loosely until all brackets are in place.  
Tighten all bolts after all brackets are in place.***

***Important Notice*** - It may be necessary to remove some aftermarket items (light bars, luggage racks, etc.) before installation of hitch brackets. After hitch is installed, aftermarket items can be reattached.

***Some aftermarket accessories may not be compatible with InstaTrike.***

- 1) Place motorcycle on a smooth level surface on its center stand.
- 2) Remove saddle bags
- 3) ***Ensure saddle bag sub frame / crashbar bolts are tight***
- 4) Attach bracket **A** (left side) to forward portion of saddle bag sub frame using U-bolts provided. Bracket attaches to ***underside*** of subframe
- 5) Attach bracket **B** (right side) to forward portion of saddle bag sub frame using U-bolts provided. Bracket attaches to ***underside*** of subframe

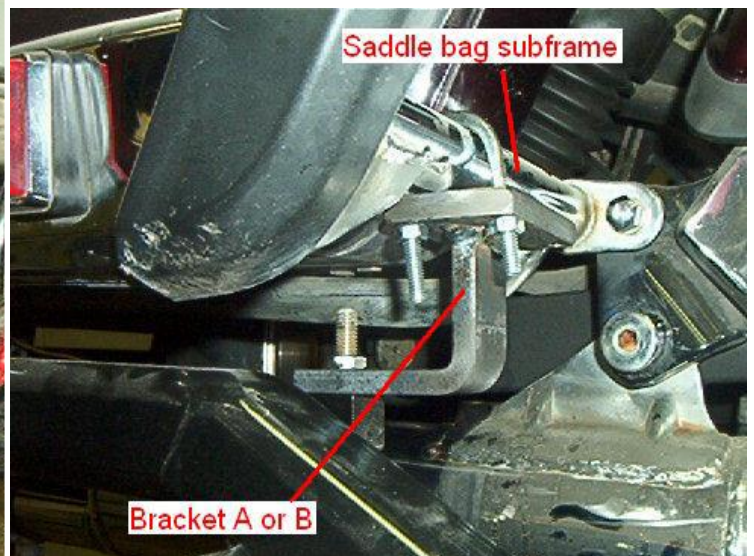
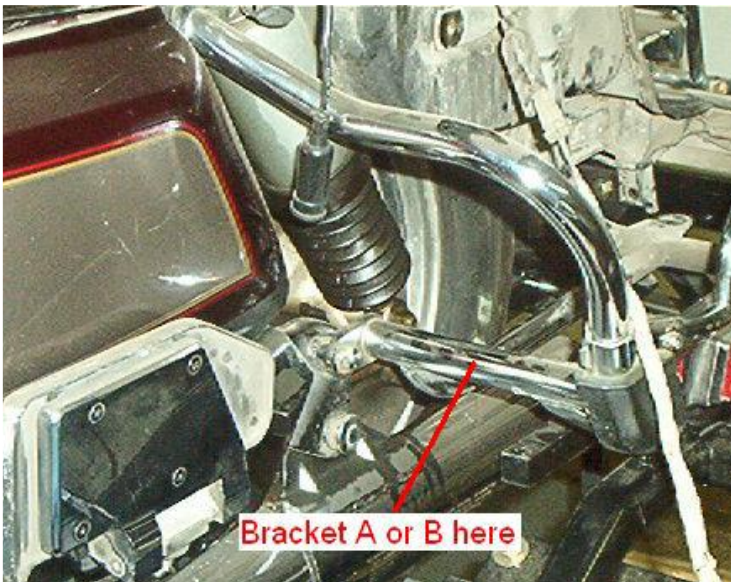

6) Attach bracket **C** (left) and bracket **D** (right) to *inside* of rear sub frame cross member. Use new bolts provided. (2 each side) This cross member is located just inside the rear fender and connects the left and right side saddle bag sub frames in the rear.

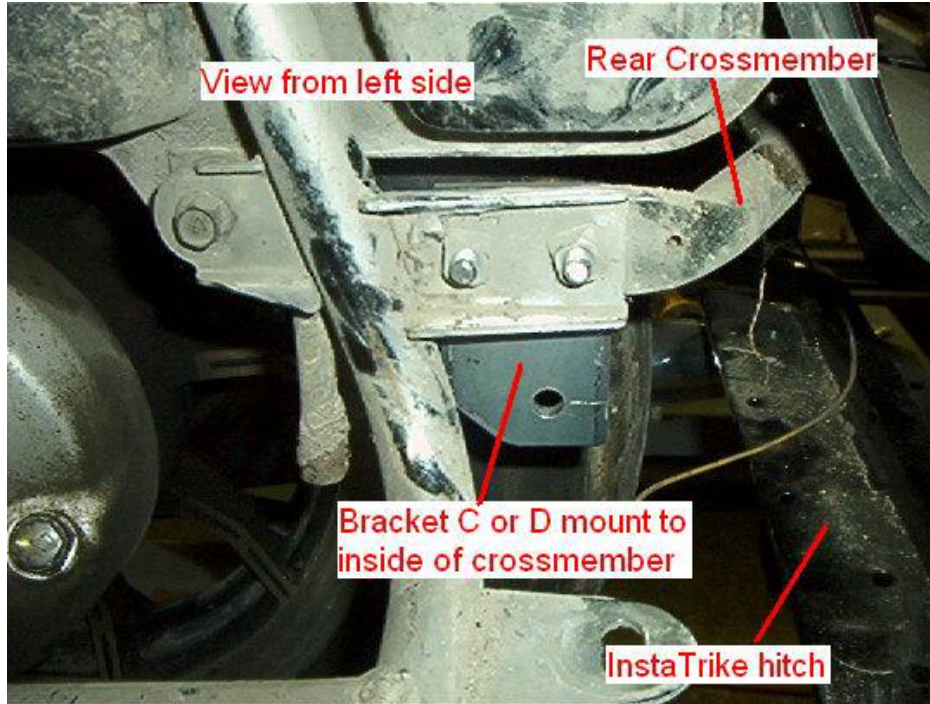

7) Attach top of bracket **E** (left) and bracket **F** (right) to *inside* of brackets **C**

to

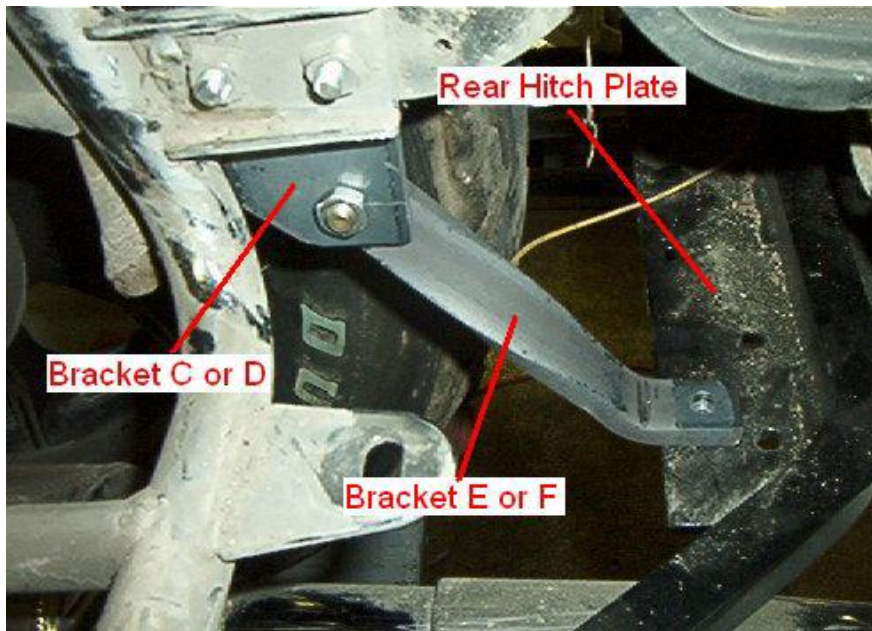

and **D**. Attach bottom of brackets rear InstaTrike hitch plate.

9) Tighten all bolts ensuring hitch is square on motorcycle.

## Receiver Hitch Diagram

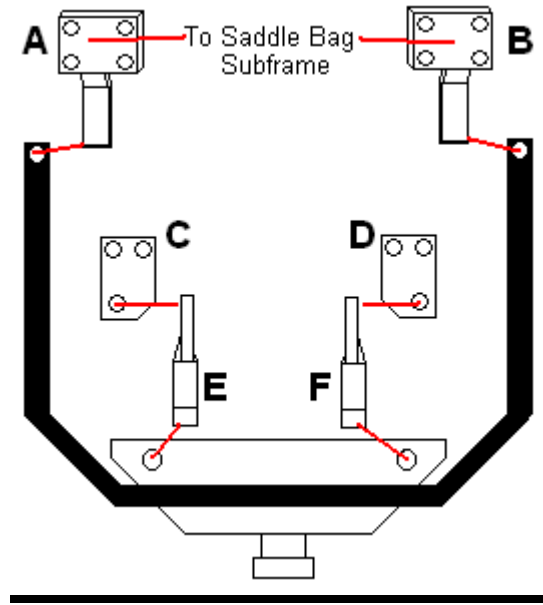

# InstaTrike Assembly Diagram

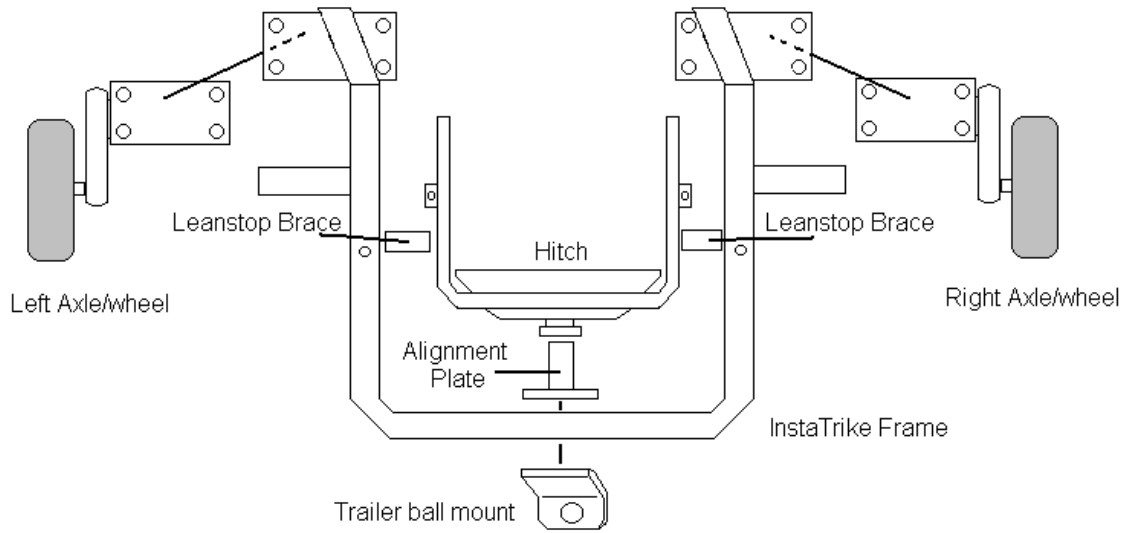

**Top View**

## INSTALLATION OF THE TOW-PAC HITCH CART.

1. Place your motorcycle on a smooth level surface on center stand.
2. Assemble axles wheels, and fenders onto the tow-pac hitch cart.
3. Enclosed  $\frac{3}{4}$  inch wooden risers may be used under InstaTrike wheels or motorcycle rear wheel in order to better align InstaTrike cart with receiver hitch.
4. Push the hitch mount into the receiver hitch. (this might be a little difficult until you get use to doing it. Removing the paint from the hitch mount and applying a little grease will help.)
5. Place the hitch pin through the receiver hitch and hitch mount (*alignment plate*). Install and tighten the tension bolt.
6. Align InstaTrike wheels. (*initial installation only. Check periodically and realign if necessary*)
7. Bolt leanstop braces to hitch. Be certain to replace washers/spacers in the same configuration as when you removed them.
8. Check all bolts for tightness.
9. You are now ready for the test ride.

- A. Keep your feet up!
- B. Ride slowly in first gear until you are comfortable with the Tow-Pac system.

## Leanstop Braces

- When installing InstaTrike, bolt leanstop brace to receiver hitch by inserting bolt from *bottom* through the leanstop brace. Thread bolt into bracket on hitch and tighten.
- When removing InstaTrike reverse the above procedure.
- Adding or removing washers/spacers between receiver hitch and leanstop brace will allow you to level your motorcycle if necessary.

(Cross Section)

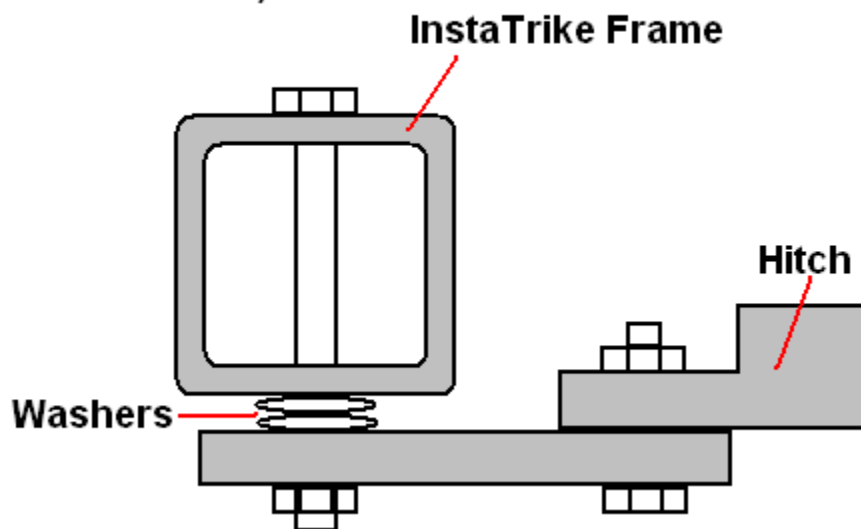

*Leanstop brace is slotted to allow for proper alignment with bolt holes*

## **NOTICE:**

Be certain that hitch bolts are inserted from the **BOTTOM**

***Periodically check hitch and alignment plate bolts for tightness.***

## **Wheel Height / Traction Adjuster**

The wheel height/traction adjuster (right and left side) allows you to selectively adjust the position of your trike wheels in order to customize ride, handling, level, and traction characteristics. Your trike is shipped with the adjuster preset to an optimum position for your model of motorcycle however you can make whatever adjustments necessary to customize to your bike and personal preference.

**Shortening** the adjuster arm **raises** the trike wheels and places more of the weight of your motorcycle on the motorcycle wheel. This increases motorcycle traction and gives a generally softer ride.

- 1) Loosen jam nuts
- 2) Shorten adjuster arm by turning adjuster nut **A** toward bolt **C** desired amount.
- 3) Turn adjuster nut **B** until it tightens against adjuster bracket and adjuster nut **A**
- 4) Tighten nuts **A** and **B** and jam nuts

**Lengthening** the adjuster arm **lowers** the trike wheels and places more of the weight of your motorcycle on the trike wheels. This gives a firmer ride and increases handling/cornering.

- 1) Loosen jam nuts
- 2) Lengthen adjuster arm by turning adjuster nut **B** toward bolt **D** desired amount.
- 3) Turn adjuster nut **A** until it tightens against adjuster bracket and adjuster nut **B**
- 4) Tighten nuts **A** and **B** and jam nuts

If necessary the pivot bolt and bolts C and D and be loosened for adjustment

***Be certain to retighten all bolts after adjustment.***

***NOTICE: Check all bolts and nuts periodically for tightness***

***NOTICE: Be sure motorcycle is level after adjustment.***

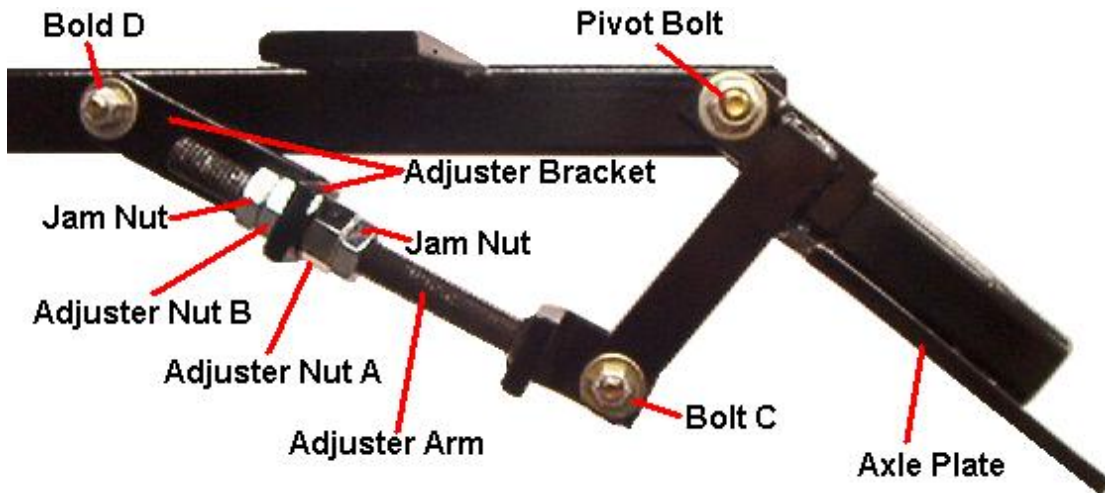

# Wheel Alignment

*Wheel alignment is critical for proper tire wear and handling.*

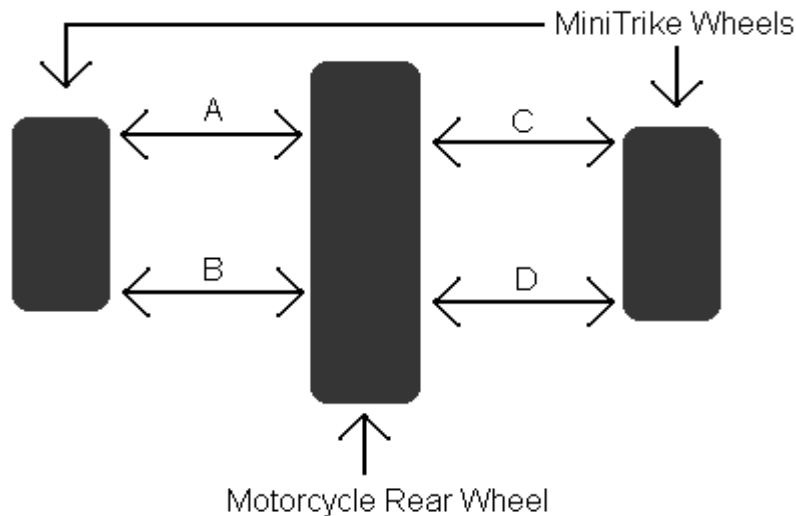

***Top View***

With InstaTrike installed and motorcycle on center stand, measure **A** and **B**. Loosen axle plates and align wheel so **A** and **B** are equal to within 1/16<sup>th</sup> of an inch. Tighten axle bolts and torque to 45 pounds. Repeat for **C** and **D**. It may

be necessary to shim axle plates for proper alignment.

**NOTE:** The measurement of A and B may not be the same as C and D. This is normal and presents no difficulty.

## **Fender Installation Instructions** *(12 Inch wheel only)*

- 1) Attach fender brackets to trike frame with spacers **BETWEEN** fender bracket and frame. Tighten.  
**NOTE: Leave fender bolts loose until all bolts are inserted.**
- 2) Place gray plastic washers between fender and trike frame/fender bracket. (4 washers each side)
- 3) Place fender on frame. Carefully align mounting holes.
- 4) Insert long bolts first. (2 each side)
- 5) Insert short bolts second. (3 each side) **Insert top bolt first.**
- 6) Carefully tighten bolts. Use care not to over tighten.

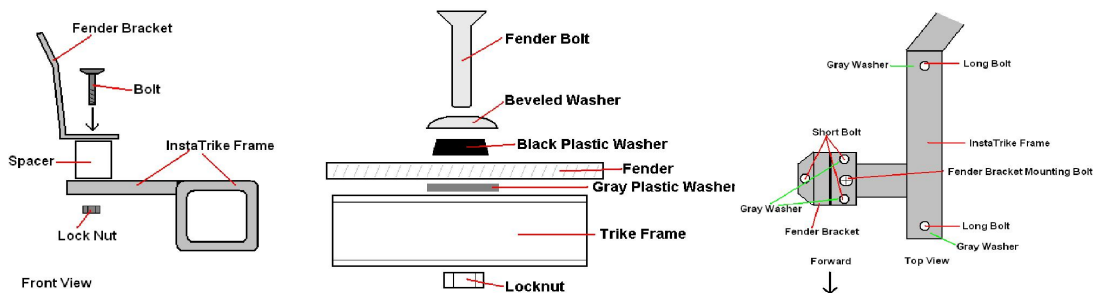

## **Reflector Mounting Instructions**

- 1) Be sure fender is clean and free from dust  
*Do not apply reflectors in direct sunlight or on a hot surface*
- 2) Remove backing from reflector and carefully position on fender.  
*See Diagram Below*

**Lightly spraying back of reflectors with a mild solution of water or Windex will allow easier positioning. Allow reflectors at least one hour to dry before riding if using this method.**

